

V1 Series

V1H0 Needle Valve

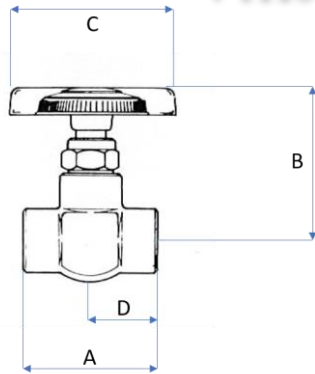

The V1 Series Needle Valve has a 37° medium tipped stem to offer rapid shut off, full flow and a semi-metering function. It is constructed from a forged brass body, brass stem, thrust washer cap, and an O-ring seal.

- Available in angle and straight patterns
- Bracket or panel mount

Pressure Rating:
Up to 1,000 P.S.I.
Temperature Rating
-40° to 250° F

Part No.	A	B	C	D
V1H0-J	1.44	1.31	1.38	0.71
V1H0-L	1.65	1.80	1.25	0.75
V1H0-N	1.79	1.85	1.25	0.80

Type: Angle Style: Regular

Part No.	MNPT	X	FNPT
V1H0-J	1/8"	X	1/8"
V1H0-L	1/4"	X	1/4"
V1H0-N	3/8"	X	3/8"

Type: Angle Style: Regular

Part No.	A	B	C	D
V1H0-3A-J		1.31	1.38	0.71
V1H0-3A-L	1.65	1.80	1.25	0.75
V1H0-3A-N	1.79	1.85	1.25	0.80

Type: Angle Style: Panel Mounting

Part No.	MNPT	X	FNPT
V1H0-3A-J	1/8"	X	1/8"
V1H0-3A-L	1/4"	X	1/4"
V1H0-3A-N	3/8"	X	3/8"

Type: Angle Style: Panel Mounting